

TECNOPRESS

CONTENITORI PER ALIMENTI



PROTEGGIAMO LA VOSTRA PASSIONE
OGNI GIORNO, CON 1000 FORME



TECNOPRESS

Attiva dal 1995, Tecnopress è un'azienda dinamica che produce contenitori in plastica destinati prevalentemente all'industria alimentare. La nostra politica è rivolta alla progettazione e successiva produzione di prodotti realizzati tenendo conto delle specifiche esigenze dei clienti per accrescere il valore del loro prodotto sul mercato.

TERMOFORMATURA

I nostri prodotti sono ottenuti mediante il processo di Termoformatura lavorando tutti i principali materiali. Siamo in grado di garantire ai nostri clienti la soluzione ottimale in relazione alle specifiche caratteristiche del prodotto da confezionare:

- prolungare la Shelf life degli alimenti
- giusto equilibrio trasparenza/robustezza contenitore
- possibilità di riscaldare/congelare gli alimenti direttamente nel contenitore.

L'IMBALLAGGIO NASCE INSIEME AL PRODOTTO

Fasi di lavorazione per nuovi prodotti costruiti ad hoc sulle esigenze dei nostri clienti:

- **ANALISI PREVENTIVA**
per valutare insieme che tipo di materiali utilizzare, forme e caratteristiche
- **REALIZZAZIONE DI UN PROTOTIPO**
molto simile al prodotto definitivo per consentire una valutazione dal punto di vista estetico e funzionale.
- **PROGETTAZIONE E REALIZZAZIONE DI STAMPI, attrezzature e impianti stampa** per la produzione definitiva.
- **PRODUZIONE** su commessa del lotto concordato.
- **PIANIFICAZIONE DELLE CONSEGNE** con il cliente con la possibilità di gestire anche consegne frazionate.

SETTORI DI APPLICAZIONE

VASCHEFFE PER ALIMENTI:

GASTRONOMIA, ANTIPASTI, OLIVE, CASEARIO

VASETTI PER ALIMENTI:

SALSE, CASEARIO, SUGHI, FRUTTA SECCA, PESTO

CARNI E PESCE

IV GAMMA

FRUTTA FRESCA

DOLCIARIO E PANIFICAZIONE

APPLICAZIONI INDUSTRIALI

POSSIAMO PERSONALIZZARE I NOSTRI CONTENITORI UTILIZZANDO COME TECNOLOGIA SIA L'OFFSET FINO A 7 COLORI CHE LA SHRINK SLEEVE



MATERIE PRIME UTILIZZATE PER LA PRODUZIONE DEI CONTENITORI:

MONOSTRATO

PP, PS, OPS, PET, PLA

MULTISTRATO SENZA BARRIERA

PP/PE, PS/PE, PET/PE

MULTISTRATO CON BARRIERA

PP/EVOH/PP, PP/EVOH/PE,
PS/EVOH/PE, PET/EVOH/PE
PLA-PVOH-PLA

	MATERIALI		DIMENSIONI (mm)	
	MONOSTRATO	PLURISTRATO	ESTERNO	ALTEZZA
 codice VR01	PP	PP-EVOH-PP	185 x 132	H 25 H 40
 codice VR01C2	PP	PP-EVOH-PP	185 x 132	H 25 H 38
 codice COPVR01	PP		190 x 140	
PORTA TRAMEZZINO  codice VR02	PET		182 x 115	H 30
 codice COPVR02	PET		186 x 136	
 codice VR03	PP PS		270 x 178	H 55
 codice VR04	PP PS		268 x 178	H 30 H 68



codice
VR05



codice
VR06



codice
COPVR06



codice
VR07



codice
VR08



codice
VR09



codice
VR10

MATERIALI		DIMENSIONI (mm)	
MONOSTRATO	PLURISTRATO	ESTERNO	ALTEZZA
PET		194 x 119	H 55
PP	PP-EVOH-PP	188 x 135	H 18 H 35 H 45 H 90
PET		198 x 147	
PP	PP-EVOH-PP	145 x 120	H 35 H 52
PP	PP-EVOH-PP	285 x 197	H 20 H 30 H 40 H 70
PET		215 x 165	H 66
PP PS	PP-EVOH-PP	180 x 145	H 65

	MATERIALI		DIMENSIONI (mm)	
	MONOSTRATO	PLURISTRATO	ESTERNO	ALTEZZA
<p>DUE COMPARTI</p>  <p>codice VR10C2</p>	PP PS	PP-EVOH-PP	180 x 145	H 70
 <p>codice VR11</p>	PP	PP-EVOH-PP	169 x 120	H 20 H 30 H 40 H 50 H 60
 <p>codice VR11N</p>	PP	PP-EVOH-PP	169 x 120	H 20
 <p>codice VR11H</p>	PP	PP-EVOH-PP	169 x 120	H 30
<p>OTTAGONALE</p>  <p>codice VR11</p>	PP	PP-EVOH-PP	169 x 120	H 45
<p>4 COMPARTI</p>  <p>codice VR11C4</p>	PP	PP-EVOH-PP	169 x 120	H 20
<p>2 COMPARTI</p>  <p>codice VR11C2</p>	PP	PP-EVOH-PP	169 x 120	H 60

	MATERIALI		DIMENSIONI (mm)	
	MONOSTRATO	PLURISTRATO	ESTERNO	ALTEZZA
 codice COPVR11	PET		174 x 127	
 codice VR12	PP	PP-EVOH-PP	133 x 74	H 27 H 45 H 70 H 90
 codice COP VR12	PET		145 x 85	
PORTA PANINO  codice VR15	PET PS	PS-EVOH-PE	227 x 104	H 48
 codice VR16	PP	PP-EVOH-PP	215 x 185	H 27
 codice VR18	PP	PP-EVOH-PP	302 x 190	H 35 H 65 H 72
 codice VR19C2	PP	PP-EVOH-PP	263 x 162	H 25



codice
VR20



codice
VR21



codice
VR22



codice
VR22C2



codice
VR22C4



codice
COP VR18



codice
VR19

MATERIALI		DIMENSIONI (mm)	
MONOSTRATO	PLURISTRATO	ESTERNO	ALTEZZA
PP	PP-EVOH-PP	213 x 138	H 25 H 48 H 38 H 55 H 40 H 65
PP	PP-EVOH-PP	260 x 157	H 15 H 25 H 30 H 46 H 60 H 70
PP	PP-EVOH-PP	267 x 183	H 20 H 34 H 50 H 68
PP	PP-EVOH-PP	267 x 183	H 40
PP	PP-EVOH-PP	267 x 183	H 60
PET		310 x 195	
PP	PP-EVOH-PP	263 x 162	H 15 H 20 H 42 H 50 H 60 H 70 H 95

	MATERIALI		DIMENSIONI (mm)	
	MONOSTRATO	PLURISTRATO	ESTERNO	ALTEZZA
 codice VR23	PP	PP-EVOH-PP	160 x 130	H 20 H 26 H 36 H 46
 codice COPVR23	PP		162 x 135	
 codice VR24	PP	PP-EVOH-PP	323 x 263	H 40 H 55 H 65 H 75 H 80 H 95
 codice VR25	PET		175 x 145	H 60
DUE COMPARTI  codice VR25C2	PET		173 x 145	H 60
 codice VR26	PET		137 x 137	H 70
 codice VR27	PP	PP-EVOH-PP	277 x 190	H 30 H 35

	MATERIALI		DIMENSIONI (mm)	
	MONOSTRATO	PLURISTRATO	ESTERNO	ALTEZZA
 codice VR28	PP	PP-EVOH-PP	252 x 182	H 35
 codice VR29	PP	PP-EVOH-PP	165 x 140	H 48
VASCETTA INCERNIERATA  codice VR31	PET		192 x 113	H 45
DUE COMPARTI  codice VR32	PET		160 x 128	H 46
 codice VR33	PET PS	PS-EVOH-PE PET-EVOH-PE PET-PE	298 x 215	H 70 H 90
 codice VR34	PET		178 x 178	H 30
 codice VR35	PP	PP-EVOH-PP	249 x 180	H 35 H 45 H 60

CON SEPARATORE



codice
VR35S

7 COMPARTI: 6 mini hamburger + salsa

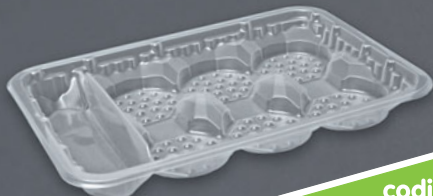

codice
VR35C7



codice
VR36



codice
COPVR36



codice
VR37

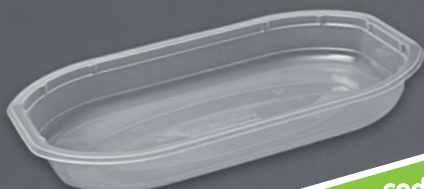

codice
VR38



codice
VR39

MATERIALI		DIMENSIONI (mm)	
MONOSTRATO	PLURISTRATO	ESTERNO	ALTEZZA
PP	PP-EVOH-PP	249 x 180	H 35
PP	PP-EVOH-PP	249 x 180	H 30
PP	PP-EVOH-PP	108 x 108	H 35 H 50 H 75
PET		114 x 114	H 10
PP	PP-EVOH-PP	225 x 117	H 20 H 25 H 45
PP	PP-EVOH-PP	262 x 152	H 32 H 45
PS	PP-EVOH-PP	240 x 180	H 55

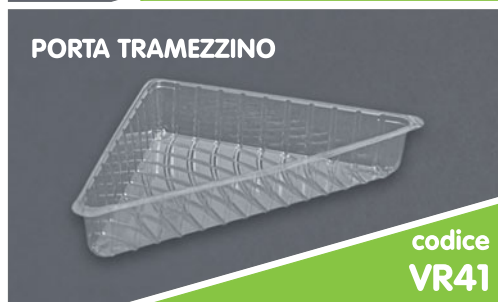

MATERIALI		DIMENSIONI (mm)	
MONOSTRATO	PLURISTRATO	ESTERNO	ALTEZZA
PS PP PET	PP-EVOH-PP	250 x 180	H 55 H 70 H 110
PET		260 x 187	
PET		212 x 118	H 32
PET		228 x 108	H 45
PP	PP-EVOH-PP	230 x 145	H 20 H 40 H 50 H 65
PP	PP-EVOH-PP	230 x 145	H 28
PP	PP-EVOH-PP	230 x 245	H 30

	MATERIALI		DIMENSIONI (mm)	
	MONOSTRATO	PLURISTRATO	ESTERNO	ALTEZZA
<p>DUE SEDI UGUALI</p>  <p>codice VR44C2</p>	PP	PP-EVOH-PP	230 x 145	H 30
<p>DUE COMPARTI</p>  <p>codice VR44C2BP</p>	PP	PP-EVOH-PP	230 x 145	H 50
<p>DUE COMPARTI</p>  <p>codice VR44C2SC</p>	PP	PP-EVOH-PP	230 x 145	H 50
 <p>codice VR44W4</p>	PET PP	PP-EVOH-PP	230 x 145	H 30
 <p>codice VR45</p>	PP	PP-EVOH-PP	81 x 65	H 21 H 45
<p>SALSE</p>  <p>codice VR46</p>	PP	PP-EVOH-PP	135 x 83	H 40
 <p>codice VR50</p>	PP	PP-EVOH-PP	190 x 134	H 35 H 65



MATERIALI		DIMENSIONI (mm)	
MONOSTRATO	PLURISTRATO	ESTERNO	ALTEZZA
PP	PP-EVOH-PP	190 x 139	H 28
PP	PP-EVOH-PP	190 x 134	H 36
PP	PP-EVOH-PP	190 x 134	H 30
PET		184 x 127	H 36 H 43
PP	PP-EVOH-PP	267 x 130	H 25
PP	PP-EVOH-PP	117 x 117	H 45 H 55
PET		123 x 123	

	MATERIALI		DIMENSIONI (mm)	
	MONOSTRATO	PLURISTRATO	ESTERNO	ALTEZZA
 codice VR55	PP PET	PET-EVOH-PP PET-EVOH-PE	160 x 160	H 25
 codice VR56	PP PET	PET-EVOH-PP	112 x 112	H 40
 codice COPVR56	PET		116 x 116	H 15
 codice VR58	PP	PP -EVOH-PP	110 x 200	H 30
 codice VR500 VR600 VR750 VR1000	PET PET PET PET		140 x 125 190 x 145 190 x 145 190 x 145	H 55 H 50 H 55 H 65
 codice VT500 VT750 VT1000	PET PET PET		160 x 135 200 x 170 200 x 170	H 55 H 55 H 70
 codice VPT85	PS	PS -EVOH-PE	182 x 62	H 85



MATERIALI		DIMENSIONI (mm)	
MONOSTRATO	PLURISTRATO	ESTERNO	ALTEZZA
PS	PS -EVOH-PE	190 x 90	H 93
PP PET	PP-EVOH-PP	285 x 245	H 27 H 50
PP	PP-EVOH-PP	Ø 300	H 27
PET		Ø 305	
PP	PP-EVOH-PP	235 x 150	H 58
		INTERNO	INTERNO
		210 x 125	H 48
PP	PP-EVOH-PP	316 x 130	H 48
		INTERNO	INTERNO
		299 x 111	H 38
PP	PP-EVOH-PP	Ø 190	H 65

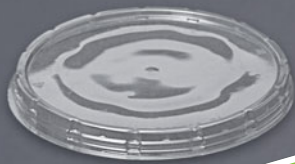

codice
CT06







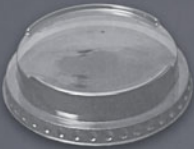

codice
T13

MATERIALI		DIMENSIONI (mm)	
MONOSTRATO	PLURISTRATO	ESTERNO	ALTEZZA
PET		Ø 199	H 16
PS PET		Ø 230	H 70

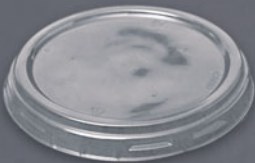

	MATERIALI		DIMENSIONI (mm)	
	MONOSTRATO	PLURISTRATO	ESTERNO	ALTEZZA
 codice T01	PP	PP-EVOH-PP	Ø 78	H 45 H 55 H 85
 codice CT01	PS PP PET		Ø 86	
 codice T04	PS PP	PP-EVOH-PP	Ø 80	H 45 H 55
 codice CT04	PET		Ø 227	
 codice T07	PP	PP-EVOH-PP	Ø 93	H 25 H 40 H 70 H 115
ARROTONDATO  codice T07	PP	PP-EVOH-PP	Ø 93	H 35 H 57
 codice CT07	PET		Ø 100	

	MATERIALI		DIMENSIONI (mm)	
	MONOSTRATO	PLURISTRATO	ESTERNO	ALTEZZA
 codice CT95	PET		Ø 100	
 codice T08	PP	PP-EVOH-PP	Ø 123	H 25 H 35 H 45 H 52 H 60 H 94
 codice CT08R	PET		Ø 129	
 codice CT08D	PET		Ø 129	
 codice CT08	PET		Ø 126	
 codice T09	PP	PP-EVOH-PP	Ø 100	H 54
 codice CT09	PET PS		Ø 107	

	MATERIALI		DIMENSIONI (mm)	
	MONOSTRATO	PLURISTRATO	ESTERNO	ALTEZZA
 codice T11	PP	PP-EVOH-PP	Ø 125	H 65
 codice CT11	PS PET		Ø 132	
 codice T12	PP	PP-EVOH-PP	Ø 108	H 40 H 57 H 67 H 77 H 92
RIGATO  codice T12R	PP	PP-EVOH-PP	Ø 108	H 92
DODECAGONALE  codice T12D	PP	PP-EVOH-PP	Ø 108	H 67
 codice CT12EST	PET		Ø 114	H 16
 codice CT12INT	PET		Ø 95	H 18

	MATERIALI		DIMENSIONI (mm)	
	MONOSTRATO	PLURISTRATO	ESTERNO	ALTEZZA
 codice CB01	PET		Ø 92	
 codice CB02 CB03 CB04 CB05 CB06 CB07	PET PET PET PET PET PET		Ø 91 Ø 103 Ø 109 Ø 120 Ø 130 Ø 136	H 41 H 41 H 42 H 43 H 45 H 45
 codice T14	PP	PP-EVOH-PP	Ø 65	H 30
 codice T15	PET	PET-EVOH-PE	Ø 228	H 20
 codice T16	PP	PP-EVOH-PP	Ø 73	H 55
 codice CT16	PET		Ø 79	



codice
VAL-86-L6



codice
PORTA UOVA

PORTA PIZZA



codice
CP1



codice
TEE011



codice
TEE001



codice
TE002



codice
TE0021

MATERIALI		DIMENSIONI (mm)	
MONOSTRATO	PLURISTRATO	ESTERNO	ALTEZZA
PS		290 x 220	H 86
PS PP		315 x 105	H 70
PP		Ø int. 320	H 35
PS		195 x 110	H 70
PS		205 x 145	H 70
PS		220 x 230	H 70
PS		250 x 260	H 70



codice
PIATTOPARTY



PORTA BOMBOLETTE

codice
VR43

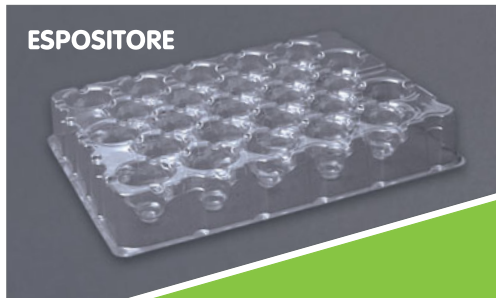

ESPOSITORE

MATERIALI		DIMENSIONI (mm)	
MONOSTRATO	PLURISTRATO	ESTERNO	ALTEZZA
PS		274 x 210	H 24
	PET	167 x 117	H 20
	PET	270 x 210	H 40



LINEA C - CONTENITORI COMPONENTI



codice
C20



codice
C35



codice
C60

MATERIALI	DIMENSIONI (mm)	
	MONOSTRATO	ESTERNO
PET	187 x 115	H 20
PET	187 x 115	H 35
PET	187 x 115	H 60
PET	95 x 180	H 33
PET	95 x 180	H 40
PET	95 x 180	H 45
PET	185 x 185	H 42,5
PET	185 x 185	H 40
PET	185 x 185	H 37,5
PET	185 x 185	H 25
PET	185 x 185	H 36
PET	182 X 280	H 34
PET	182 X 280	H 42,5
PET	182 X 280	H 40
PET	260 X 290	H 40
PET	260 X 290	H 37,5

LINEA F - FRUTTI TONDI



codice

F2-66

F2-80

F2-90



codice

F4-15

F4-23

F4-51

F4H25

F4H31



codice

F6-15

F6-22

F6-27



codice

F9-22

F9-27

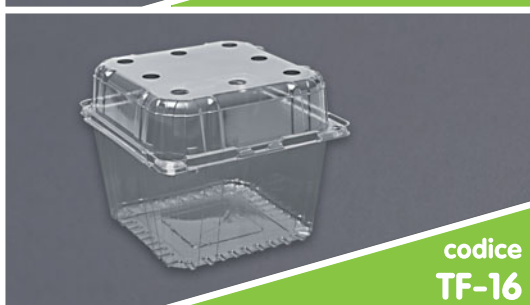
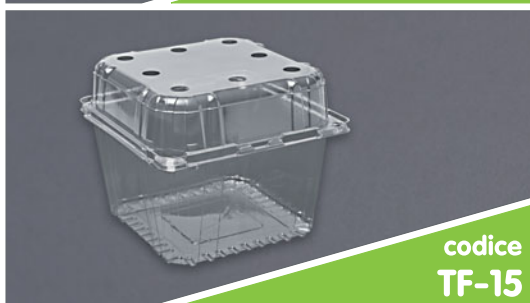
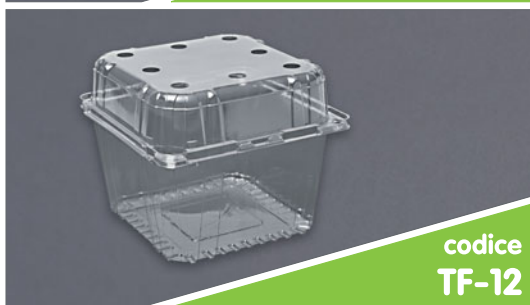

MATERIALI	DIMENSIONI (mm)	
	MONOSTRATO	ESTERNO
PET	185 x 185	H 70
PET	185 x 185	H 90
PET	185 x 185	H 120
PET	185 x 185	H 150
PET	185 x 185	H 160
PET	239x163 x 141	H 160

RICERCA, TECNOLOGIA E AMBIENTE

TECNIOPRESS per differenziarsi dai competitors mette in campo volontà, risorse e capacità con l'obiettivo di studiare nuove soluzioni a livello di materiali, forme e performance in maniera tale da assicurare ai propri clienti il giusto rapporto costo beneficio. La ricerca e sviluppo è resa possibile dalla nostra convinzione sulla sua importanza, dal personale altamente qualificato e dalla presenza di una adeguata strumentazione di laboratorio che sfruttando le tecnologie più avanzate permette di caratterizzare e controllare i principali parametri delle materie prime, dei film e dei termoformati.

IL SUCCESSO DIPENDE DALLE SCELTE,
DALLE BUONE SCELTE

TECNIOPRESS srl
sede legale: via Newton,37
47025 Mercato Saraceno (FC)
Tel. 0547 90158 | Fax. 0547 91200
sede operativa: zona industriale Villa Zaccheo
64020 Castellatao (TE)
Tel. 0861 296017
tecnopress.biz